



BREAK OUT KIT ACCESS

2 mm de 12 fibras



NÚMERO DE PARTE

OPMIB0KFB12CI2MM

*Imagen del producto solo representativa

DESCRIPCIÓN

El Break-Out Kit de Optronics, ofrece un diseño modular, compacto y flexible, permite el ajuste de las fibras sin la necesidad de equipo o herramientas especiales. Proporciona protección al buffer de 900 μm , además de agrandarlo a 2 mm.

Los tubos tienen una longitud aproximada de 1m, el código de color de cada tubo es conforme a la norma ANSI/TIA-598-D para la distribución y administración de las fibras ópticas.

Simplifica la terminación de las fibras en campo. El Break-Out Kit de Optronics se convierte en una herramienta indispensable para la terminación del cableado.



Agranda buffer de 900 μm a 2 mm



Compatibilidad en fibras multimodo o monomodo



Flexible



Fácil de instalar



Protección a fibras



1 m de longitud



/optronicsmx



BREAK OUT KIT ACCESS

2 mm de 12 fibras



ESTRUCTURA



- 1 Ojillo
- 2 Kit de tubing
- 3 Housing

APLICACIÓN

Los Break out se convierten en una herramienta indispensable para la terminación de troncales de fibra óptica.

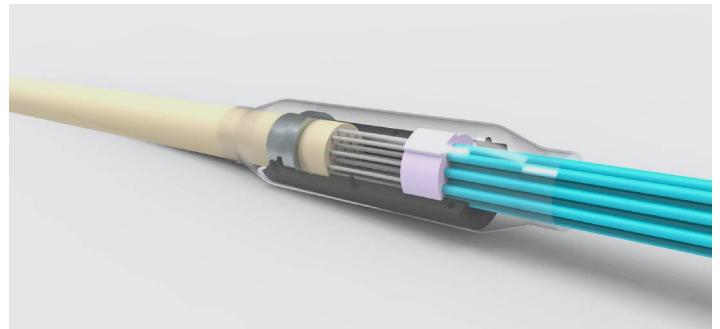
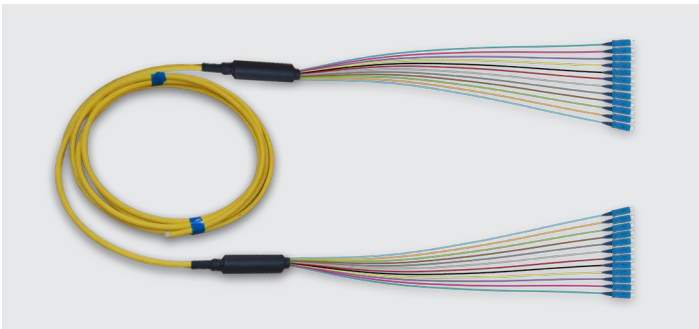

ESPECIFICACIONES GENERALES

Housing	Material	PBT + 30% Fibra de vidrio	
	Dimensiones	Diametro: 17 mm	Longitud: 65 mm
Ojillo	Material	Aluminio	
	Dimensiones	Diametro cable: 6 - 7 mm	Longitud: 23.6 ± 0.2 mm
Kit de Tubing 12 Colores	Material	PBT + fibra de vidrio y tubing Riser	
	Dimensiones	12 Tubing 2 mm de 1.0 m + 10% de longitud	

Estandares de Cumplimiento

RoHS





ANSI/TIA-598



BREAK OUT KIT ACCESS

2 mm de 12 fibras



ACCESORIOS		
CANTIDAD	DESCRIPCIÓN	IMAGEN REPRESENTATIVA
1	Ojillo	
1	Housing	
1	Kit de tubing 12 colores	
1	Termo para housing 19.1 x 79 mm	
1	Termo para cable 11 x 35 mm	



BREAK OUT KIT ACCESS

2 mm de 12 fibras



DIBUJO TÉCNICO

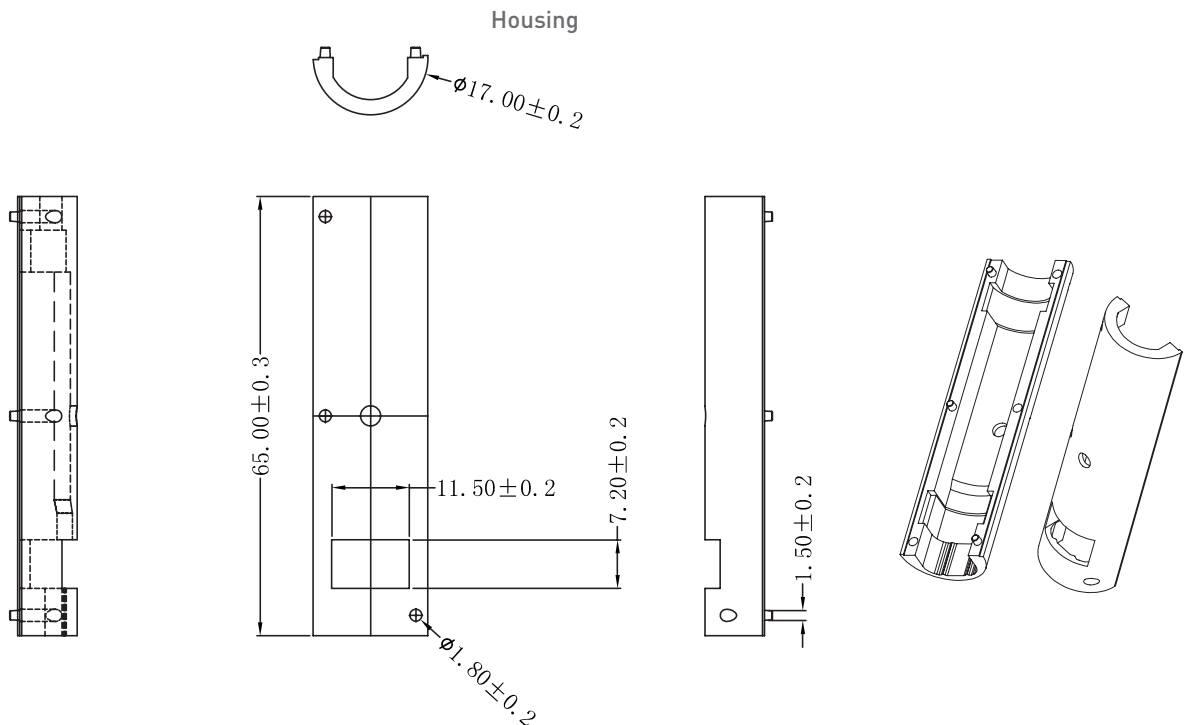
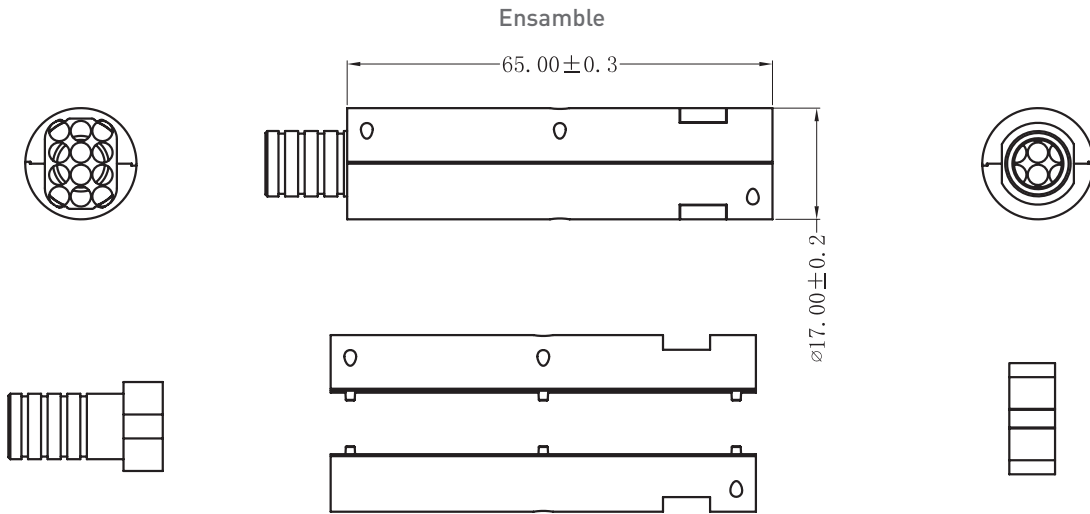



BREAK OUT KIT ACCESS

2 mm de 12 fibras

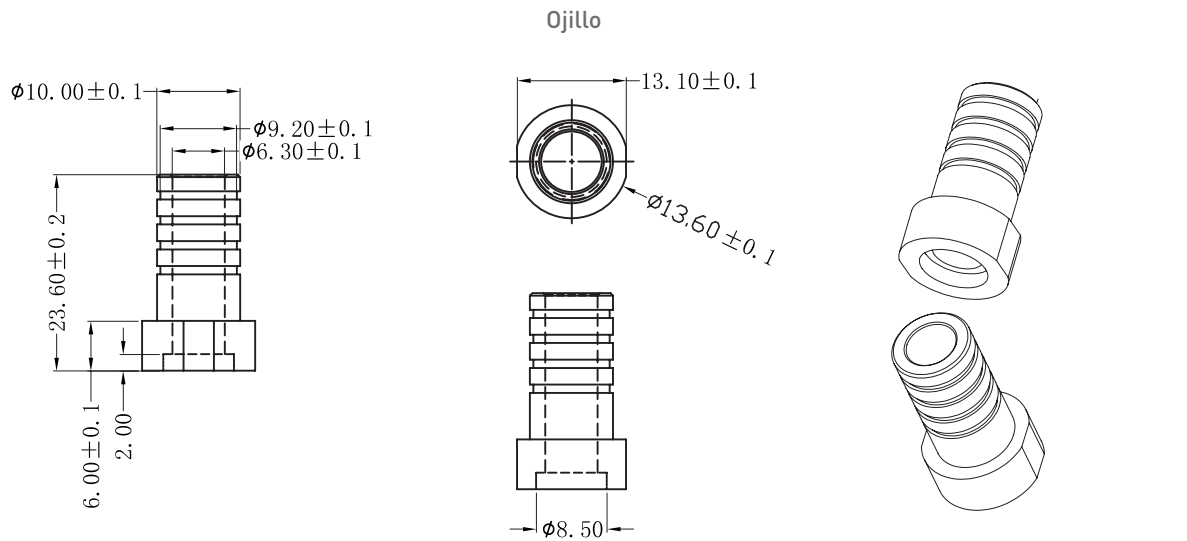

PRODUCTOS RELACIONADOS



**Bote dispensador
de alcohol**
OPMIBOT



Limpiador de férulas
OPHEC15AE



**Casete limpiador
de férulas**
OPHECCASETG



**Malla expandible
para protección**
OPMIME02



Kit Fiber Clean OP
OPHEFCOP



**Microscopio
de inspección**
OPEMFVM100



OTDR
OPEMFH051



Distribuidor 4 UR
OPDIRA4UV